

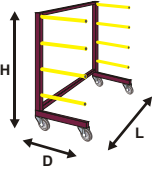

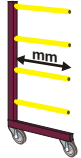

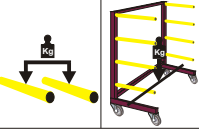

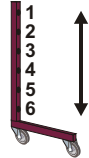





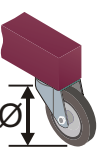

 Mobile Racks at a glance	 L x D x H	 Length	 Max. loading capacity for even loading, shock force avoided	 Slot grit	 Layers	 Clearance	 Bar Ø	 Wheel Ø
DABELJU® Spacesaving, for universal use	 Lmax 1,500 mm Lmin . . . 300 mm D 790 mm H . . . 1,805 mm							
B590 For furniture items, the handy Rack	 L . . . 1,500 mm ^{S)} <i>Lmax . 2,100 mm^{S)}</i> D 730 mm H . . . 1,810 mm	590 mm	30 kg	200 kg	16	16	66 mm	23 mm 125 mm
B590-X For furniture items, adjustable length	 Lmax 1,500 mm Lmin . . . 250 mm D 730 mm H . . . 1,810 mm							
R660 For furniture items, for heavy loads	 L . . . 1,500 mm ^{S)} <i>Lmax . 2,780 mm^{S)}</i> D 830 mm H . . . 1,920 mm							
R660X Adjustable length, for heavy loads	 Lmax 1,600 mm Lmin . . . 360 mm D 830 mm H . . . 1,920 mm	660 mm <i>(770 mm)^{S)}</i> <i>(900 mm)^{S)}</i> <i>(1000 mm)^{S)}</i>	55 kg <i>(45 kg)</i> <i>(40 kg)</i> <i>(35 kg)</i>	500 kg	31	16 <i>11^{S)}</i>	66mm <i>113mm¹⁾</i>	29 mm 160 mm
R660XX Extra long, For hevly loads	 Lmax 3,200 mm Lmin . . . 360 mm D 830 mm H . . . 1,920 mm							
B770 For doors, the standard rack	 L . . . 1,500 mm ^{S)} <i>Lmax . 2,780 mm^{S)}</i> D 940 mm H . . . 1,840 mm							
B770-X For doors, adjustable length	 Lmax 1,500 mm Lmin . . . 360 mm D 940 mm H . . . 1,840 mm	770 mm <i>(900 mm)^{S)}</i> <i>(1000 mm)^{S)}</i> <i>(1100 mm)^{S)}</i>	45 kg <i>(40 kg)</i> <i>(35 kg)</i> <i>(32 kg)</i>	500 kg	12	12	92 mm	29 mm 160 mm
B770-XX For doors, extra long	 Lmax 3,000 mm Lmin . . . 360 mm D 940 mm H . . . 1,840 mm							
R900 For doors, extra deep	 L . . . 1,500 mm ^{S)} <i>Lmax . 2,780 mm^{S)}</i> D . . . 1,060 mm H . . . 1,920 mm							
R900-X Adjustable length, extra deep	 Lmax 1,600 mm Lmin . . . 360 mm D . . . 1,060 mm H . . . 1,920 mm	900 mm <i>(1000 mm)^{S)}</i> <i>(1100 mm)^{S)}</i>	40 kg <i>(35 kg)</i> <i>(32 kg)</i>	500 kg	31	11 <i>16^{S)}</i>	113mm <i>66mm¹⁾</i>	29 mm 160 mm
R900-XX Extra long, extra deep	 Lmax 3,200 mm Lmin . . . 360 mm D . . . 1,060 mm H . . . 1,920 mm							

Änderungen vorbehalten!

^{S)} As a special order or adapted at a later date.
¹⁾ If the Mobile Rack is equipped with 11 carrying bars.
¹⁶⁾ If the Mobile Rack is equipped with 16 carrying bars.

Example for a type designation with equipment level

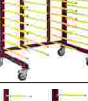
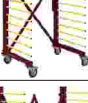
B590 - 2/2

Type designation ↑ ↑ ↑

Number of slot in racks

Number of fully equipped fix rack poles

The standard levels of equipment:

 E.g. B770-2/2
 For universal use. Suitable for long and short pieces at the same time.

 E.g. B770-1/1
 Variable. Slot in racks and carrying bars can be added.

 E.g. B770-2/0
 Only for long pieces. Slot in racks can be added at a later date.